

QTE2.0 FD30S c/w FD30S Fanlight - SBD - PAS24 : 2016

1. Door Colour - TBC
2. Frame Colour - White NCS S0502Y
3. Threshold - Drop seal c/w 80x20mm hardwood cill (*Fitted*)
4. SAA Hinges (*Fitted*)
5. Nickel Anti-Bump/Snap Euro Cylinder (Key/Turn) (*Fitted*)
6. Keep Op. 3 Point Lock (*Fitted*)
7. SAA Letterplate (Soterian) (*Fitted*)
8. Chrome Door Chain (*Loose*)
9. Chrome 75mm Numerals (*Loose*)
10. SAA Spyhole (*Fitted*)
11. SAA Dorma TS71 Overhead door closer (*Loose*)

- 1no. Set 70x12mm R2A finished in White NCS S0502Y to match the frame.
- High Security 3 point locking system to DIN 18103.Ø Euro Cylinder* - Key /Thumb + Cylinder Guard (inc 3 Keys)

ELEVATION
SCALE 1:20

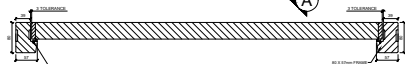
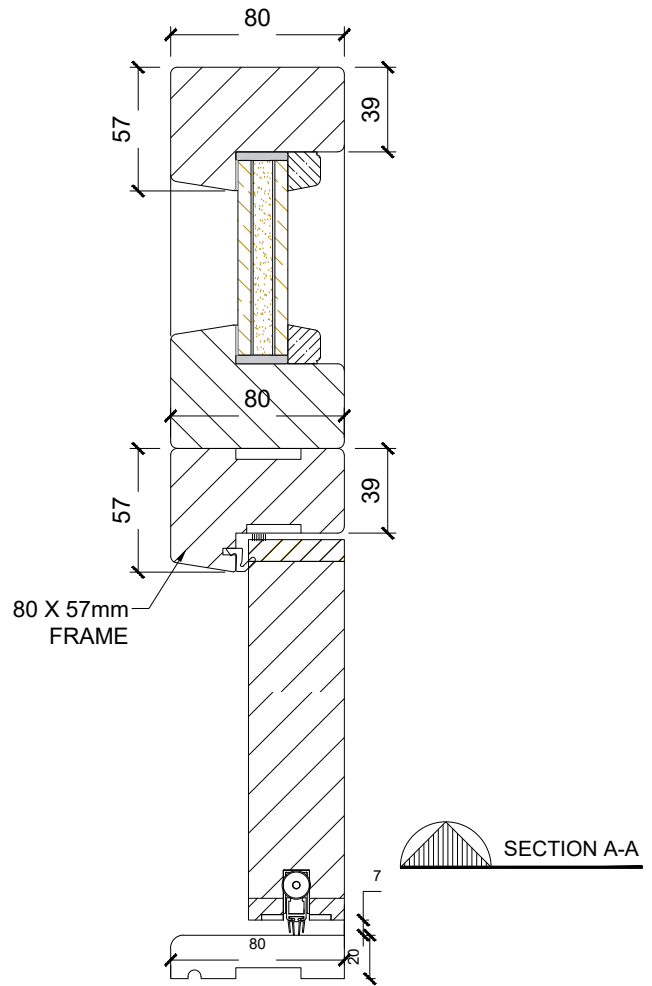

Quote Ref: D27 & D28
 QTE2.0 FD30S c/w FD30S Fanlight - SBD - PAS24 : 2016
 Handing: LH IN (Hinge viewed externally)
 Door Leaf: 926x2034mm (Varies RTT to survey)

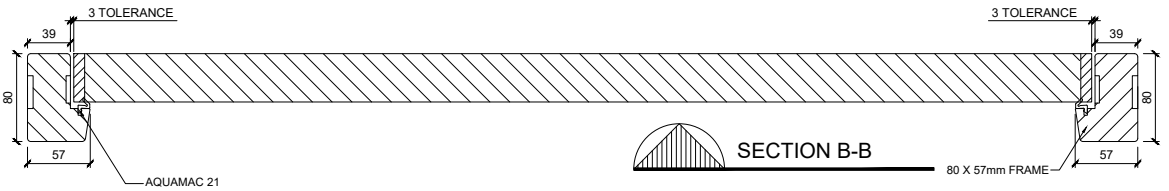

REVISION	ALTERED	DATE	DESCRIPTION
CLIENT:	United Living		SITE: X251 Regency & Semley
TITLE:	Hide Tower - QTE2.0 FD30S c/w FD30S Fanlight		John A Russell 8 Dilwara Avenue Whiteinch Glasgow G14 OQS
	Tel: 0141 958 0444		JOB - DRAWING No: 38067-301
	Fax: 0141 958 0333		SCALE: NTS@A4
Web: www.russelltimbertech.co.uk		DRAWN BY: JST	CHECKED: [] DATE: 19/08/20

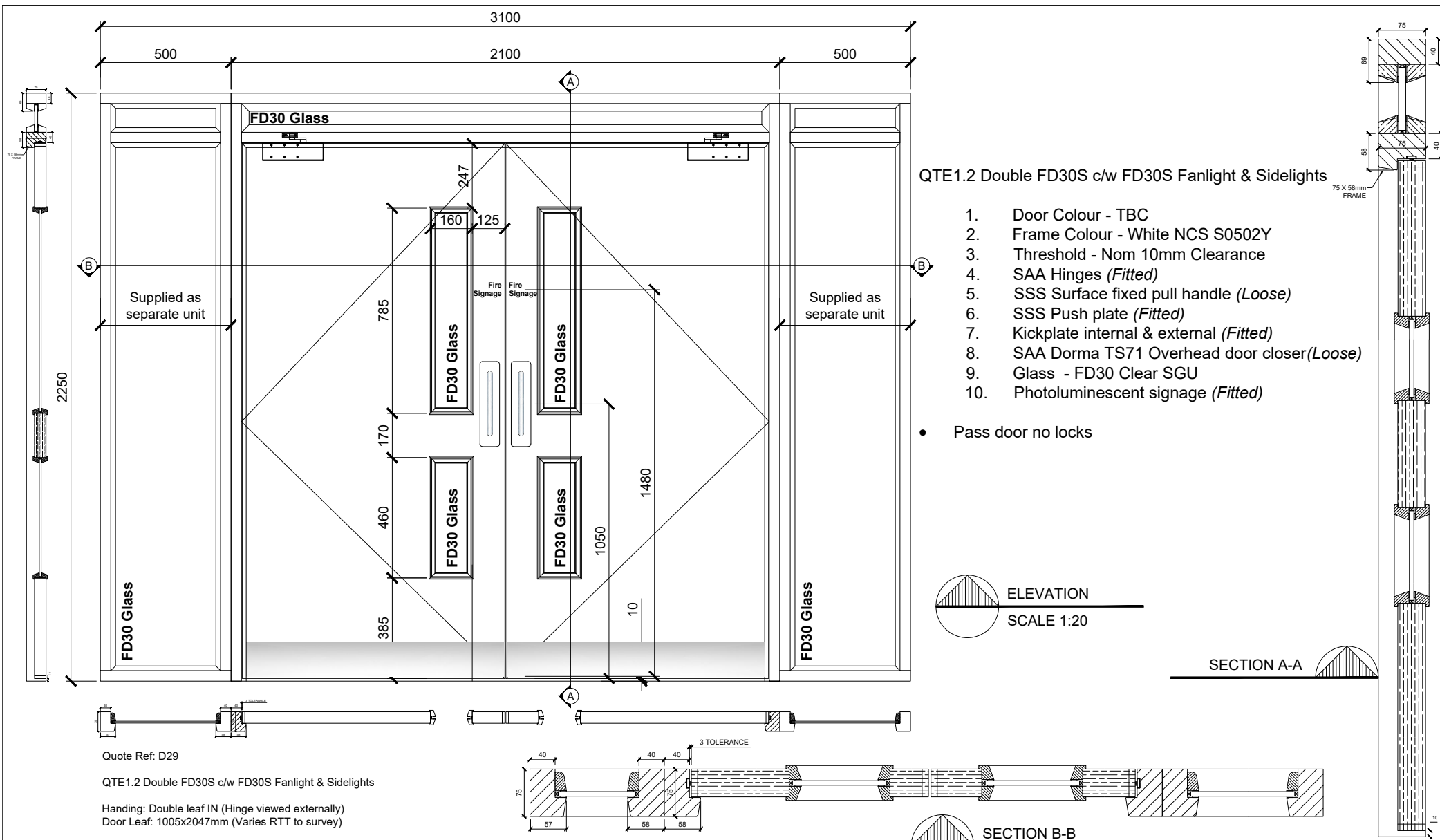

QTE1.2 Double FD30S c/w FD30S Fanlight & Sidelights

1. Door Colour - TBC
2. Frame Colour - White NCS S0502Y
3. Threshold - Nom 10mm Clearance
4. SAA Hinges (*Fitted*)
5. SSS Surface fixed pull handle (*Loose*)
6. SSS Push plate (*Fitted*)
7. Kickplate internal & external (*Fitted*)
8. SAA Dorma TS71 Overhead door closer (*Loose*)
9. Glass - FD30 Clear SGU
10. Photoluminescent signage (*Fitted*)

- Pass door no locks

 ELEVATION
SCALE 1:20

 SECTION A-A

 SECTION B-B

Quote Ref: D29
 QTE1.2 Double FD30S c/w FD30S Fanlight & Sidelights
 Handing: Double leaf IN (Hinge viewed externally)
 Door Leaf: 1005x2047mm (Varies RTT to survey)

REVISION	ALTERED	DATE	DESCRIPTION

CLIENT: United Living	SITE: X251 Regency & Semley	JOB - DRAWING No: 38067-302	
TITLE: Hide Tower - QTE1.2 Double FD30S c/w FD30S FL & SL	John A Russell 8 Dilwara Avenue Whiteinch Glasgow G14 OQS	SCALE: NTS@A4	DRAWN BY: JST CHECKED: DATE: 19/08/20



Tel: 0141 958 0444
 Fax: 0141 958 0333
 Web: www.russelltimbertech.co.uk



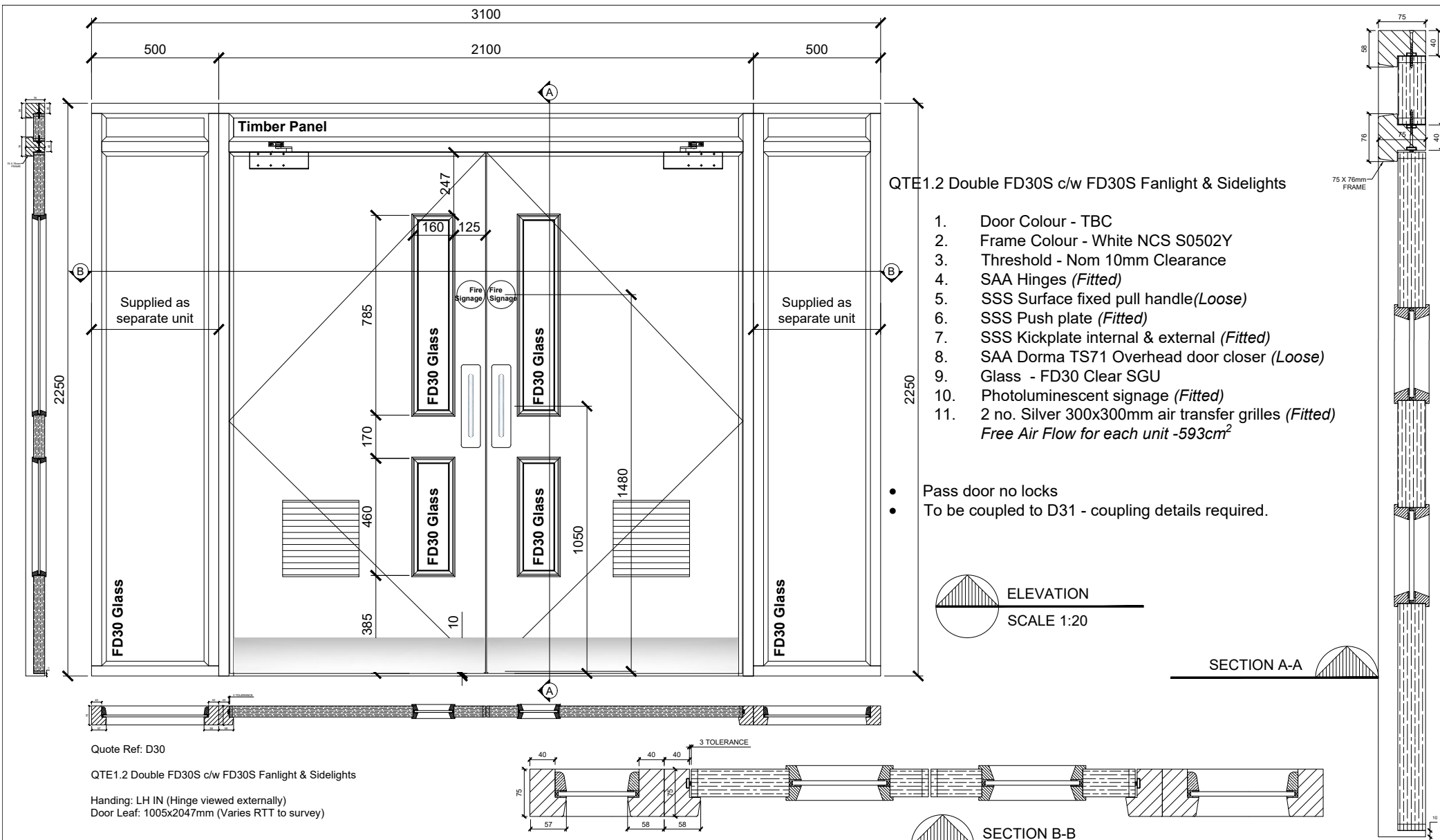

REVISION	ALTERED	DATE	DESCRIPTION

CLIENT: United Living	SITE: X251 Regency & Semley
TITLE: Hide Tower - QTE1.2 Double FD30S c/w FD30S FL & SL	John A Russell 8 Dilwara Avenue Whiteinch Glasgow G14 OQS
 RUSSELL Timber Technology Engineered to excel	JOB - DRAWING No: 38067-303
	SCALE: NTS@A4 DRAWN BY: JST CHECKED: DATE: 19/08/20



united living

Together we achieve more

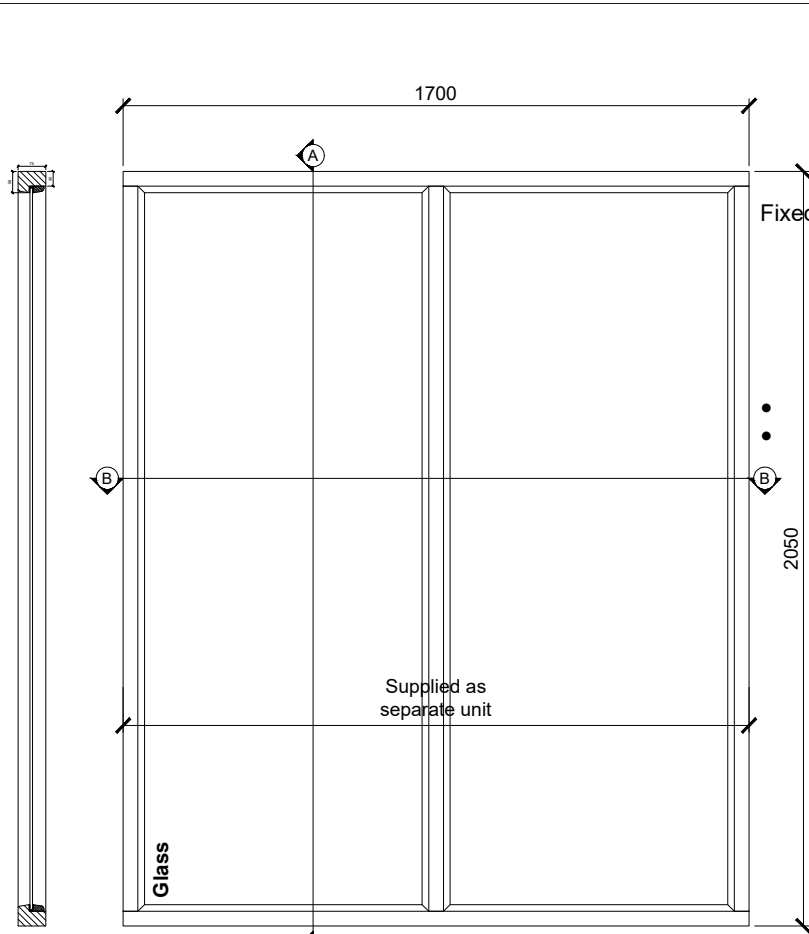

Fixed Screen

1. Frame Colour - White NCS S0502Y
2. Glass - Clear SGU

- To be coupled with D30 - Coupling details required.
- Should this screen be fire rated?

Supplied as separate unit

ELEVATION
SCALE 1:20

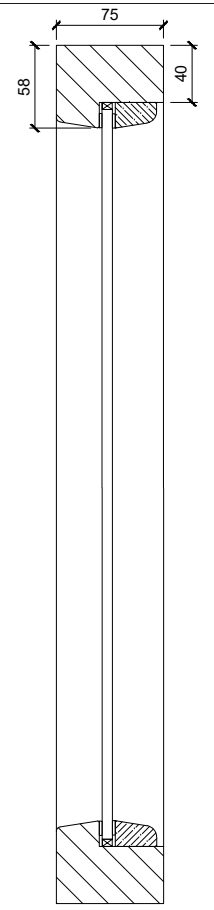

SECTION A-A

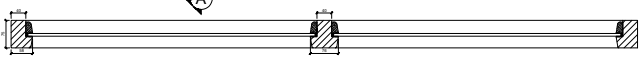

Quote Ref: D31
Fixed Screen

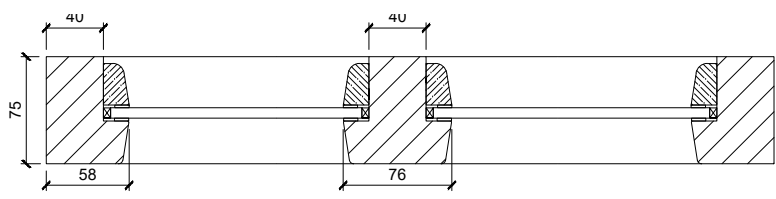

SECTION B-B

REVISION	ALTERED	DATE	DESCRIPTION

CLIENT: United Living		SITE: X251 Regency & Semley	
TITLE: Hide Tower - Fixed Screen		John A Russell 8 Dilwara Avenue Whiteinch Glasgow G14 OQS	JOB - DRAWING No: 38067-303A
 RUSSELL Timber Technology Engineered to excel	Tel: 0141 958 0444	SCALE: NTS@A4	DRAWN BY: JST
	Fax: 0141 958 0333		CHECKED: []
Web: www.russelltimbertech.co.uk			DATE: 19/08/20



united living

Together we achieve more

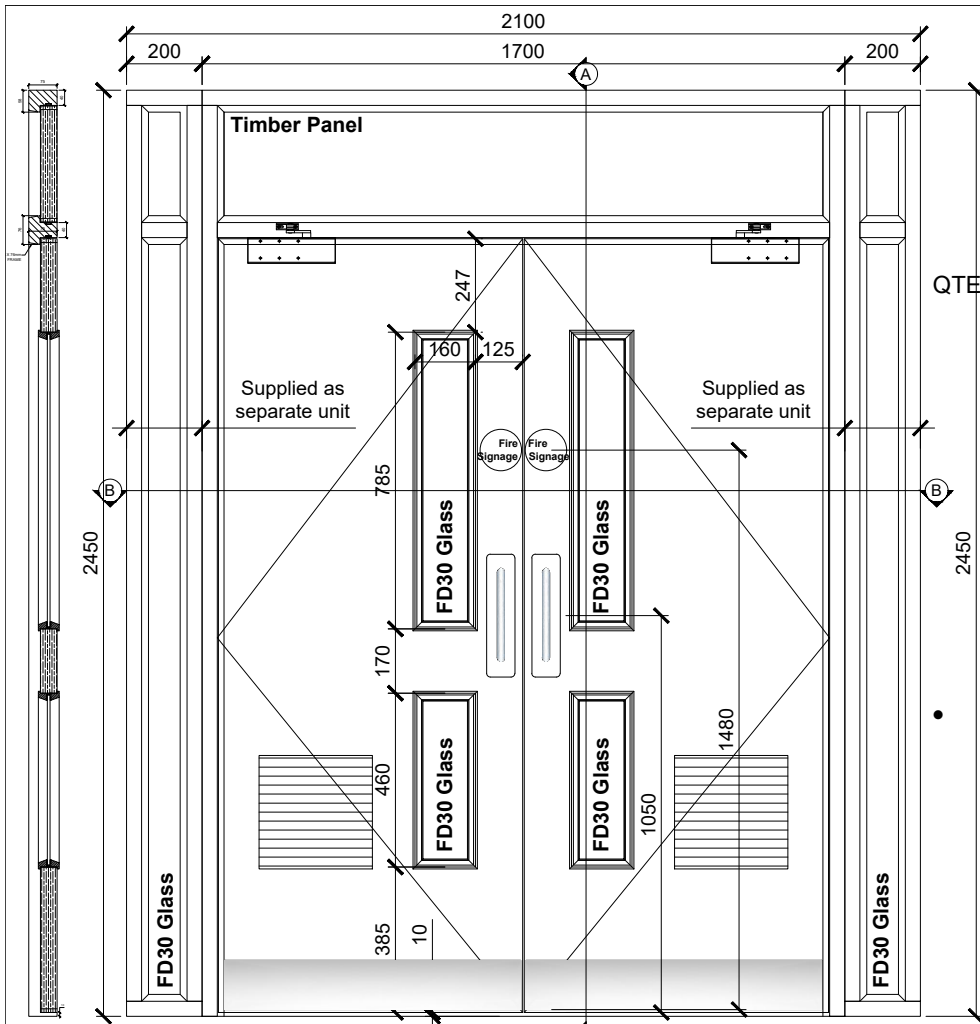

QTE1.2 Double FD30S c/w FD30S Fanlight & Sidelights

1. Door Colour - TBC
 2. Frame Colour - White NCS S0502Y
 3. Threshold - Nom 10mm Clearance
 4. SAA Hinges (*Fitted*)
 5. SSS Surface fixed pull handle (*Loose*)
 6. SSS Push plate (*Fitted*)
 7. SSS Kickplate internal & external (*Fitted*)
 8. SAA Dorma TS71 Overhead door closer (*Loose*)
 9. Glass - FD30 Clear SGU
 10. Photoluminescent signage (*Fitted*)
 11. 2 no. Silver 300x300mm air transfer grilles (*Fitted*)
- Free Air Flow for each unit -593cm²*

• Pass door no locks

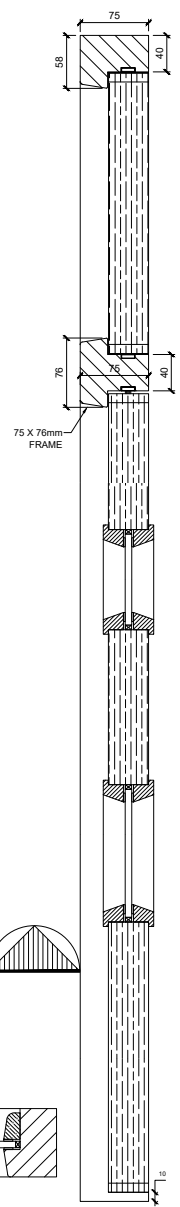

Quote Ref: D32

QTE1.2 Double FD30S c/w FD30S Fanlight & Sidelights

Handing: LH IN (Hinge viewed externally)
Door Leaf: 805x2038mm (Varies RTT to survey)

REVISION	ALTERED	DATE	DESCRIPTION

CLIENT: United Living		SITE: X251 Regency & Semley	
TITLE: Hide Tower - QTE1.2 Double FD30S c/w FD30S FL & SL		John A Russell 8 Dilwara Avenue Whiteinch Glasgow G14 OQS	
 Tel: 0141 958 0444 Fax: 0141 958 0333 Web: www.russelltimbertech.co.uk		JOB - DRAWING No: 38067-304	SCALE: NTS@A4
		DRAWN BY: JST	CHECKED:
		DATE: 19/08/20	



united living

Together we achieve more

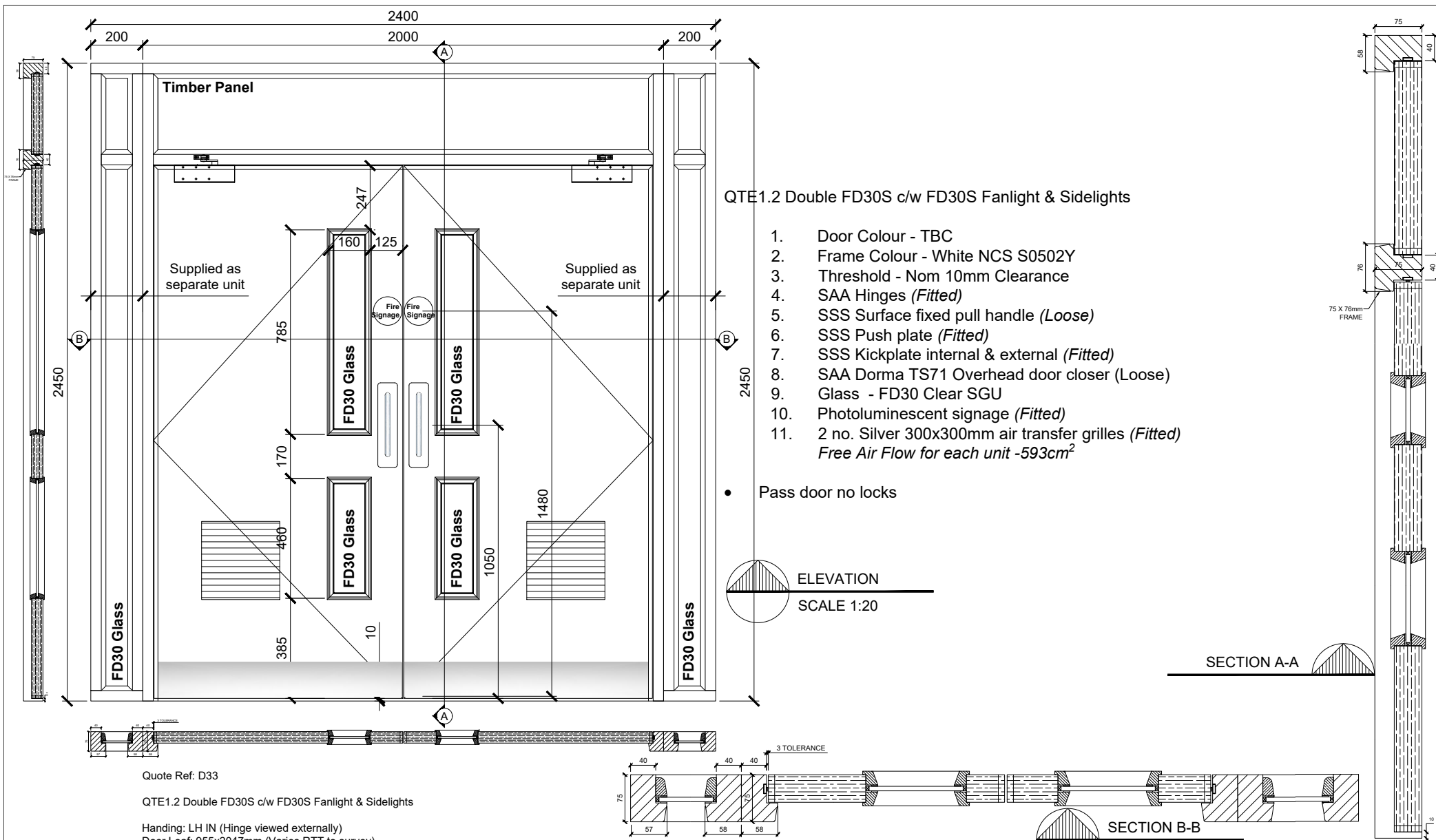

QTE1.2 Double FD30S c/w FD30S Fanlight & Sidelights

1. Door Colour - TBC
2. Frame Colour - White NCS S0502Y
3. Threshold - Nom 10mm Clearance
4. SAA Hinges (*Fitted*)
5. SSS Surface fixed pull handle (*Loose*)
6. SSS Push plate (*Fitted*)
7. SSS Kickplate internal & external (*Fitted*)
8. SAA Dorma TS71 Overhead door closer (*Loose*)
9. Glass - FD30 Clear SGU
10. Photoluminescent signage (*Fitted*)
11. 2 no. Silver 300x300mm air transfer grilles (*Fitted*)
Free Air Flow for each unit -593cm²

• Pass door no locks

ELEVATION
 SCALE 1:20

SECTION A-A

SECTION B-B

REVISION	ALTERED	DATE	DESCRIPTION

CLIENT: United Living	SITE: X251 Regency & Semley
TITLE: Hide Tower - QTE1.2 Double FD30S c/w FD30S FL & SL	John A Russell 8 Dilwara Avenue Whiteinch Glasgow G14 OQS
 RUSSELL Timber Technology Engineered to excel	JOB - DRAWING No: 38067-305
	SCALE: NTS@A4 DRAWN BY: JST CHECKED: DATE: 19/08/20



united living

Together we achieve more

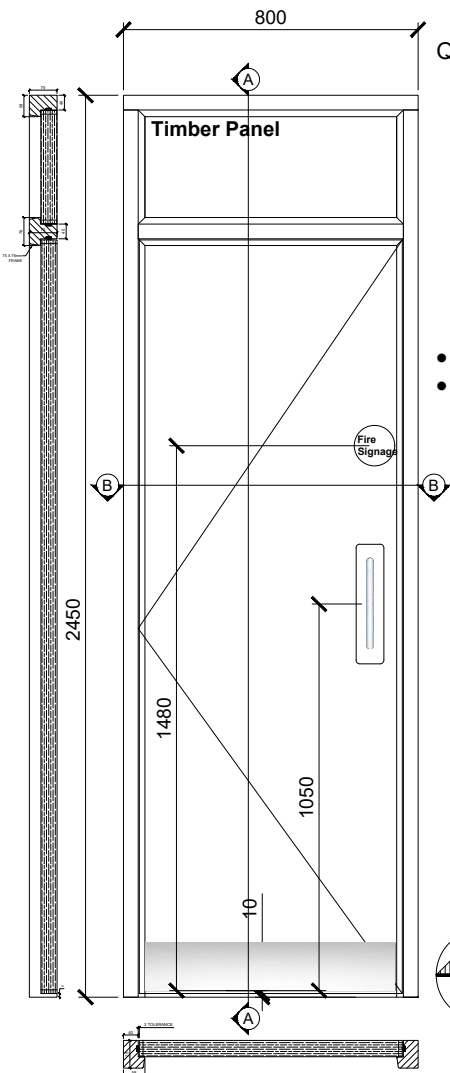

QTE1.0 FD30S c/w FD30S Fanlight

1. Door Colour - TBC
2. Frame Colour - White NCS S0502Y
3. Threshold - Nom 10mm Clearance
4. SAA Hinges (*Fitted*)
5. SSS Surface fixed pull handle (*Loose*)
SSS Push plate (*Fitted*)
6. SSS Kickplate external (*Fitted*)
7. Photoluminescent signage (*Fitted*)

- Pass door no locks
- Should this door have a closer?

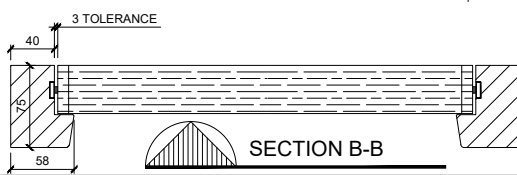
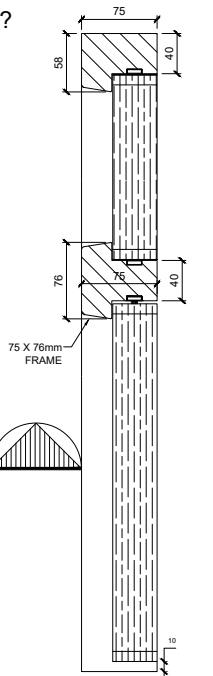
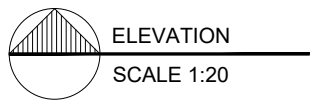

Quote Ref: D34
 QTE1.0 FD30S c/w FD30S Fanlight
 Hanging: LH IN (Hinge viewed externally)
 Door Leaf: 714x2047mm (Varies RTT to survey)

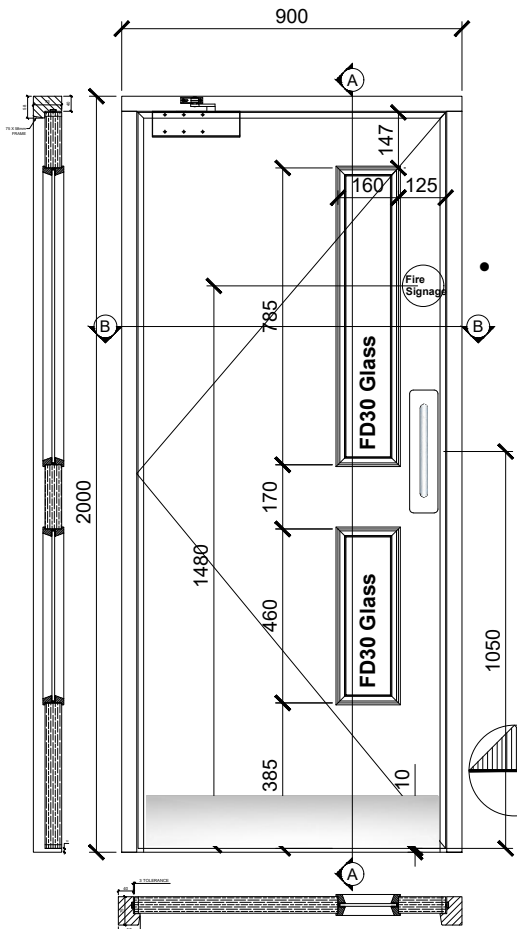

QTE1.2 FD30S

1. Door Colour - TBC
2. Frame Colour - White NCS S0502Y
3. Threshold - Nom 10mm Clearance
4. SAA Hinges (*Fitted*)
5. SSS Surface fixed pull handle (*Loose*)
SSS Push plate (*Fitted*)
8. SSS Kickplate external (*Fitted*)
9. SAA Dorma TS71 Overhead door clos
10. Glass - FD30 Clear SGU
11. Photoluminescent signage (*Fitted*)

- Pass door no locks

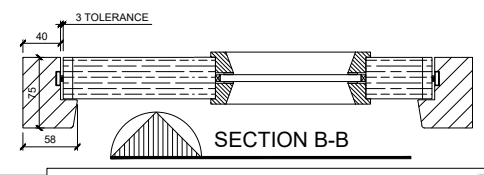
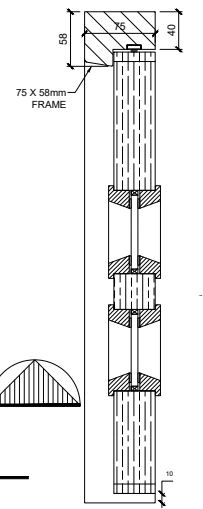
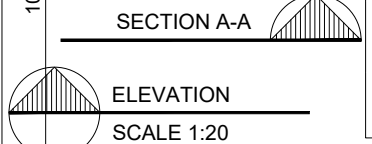

Quote Ref: D35
 QTE1.2 FD30S
 Hanging: LH IN (Hinge viewed externally)
 Door Leaf: 814x1947mm (Varies RTT to survey)

REVISION	ALTERED	DATE	DESCRIPTION

CLIENT: United Living	SITE: X251 Regency & Semley
TITLE: Hide Tower -QTE1.0 FD30S c/w FD30S FL & QTE1.2 FD30S	John A Russell 8 Dilwara Avenue Whiteinch Glasgow G14 OQS
 Tel: 0141 958 0444 Fax: 0141 958 0333 Web: www.russelltimbertech.co.uk	JOB - DRAWING No: 38067-306
	SCALE: NTS@A4 DRAWN BY: JST CHECKED: DATE: 19/08/20



united living

Together we achieve more

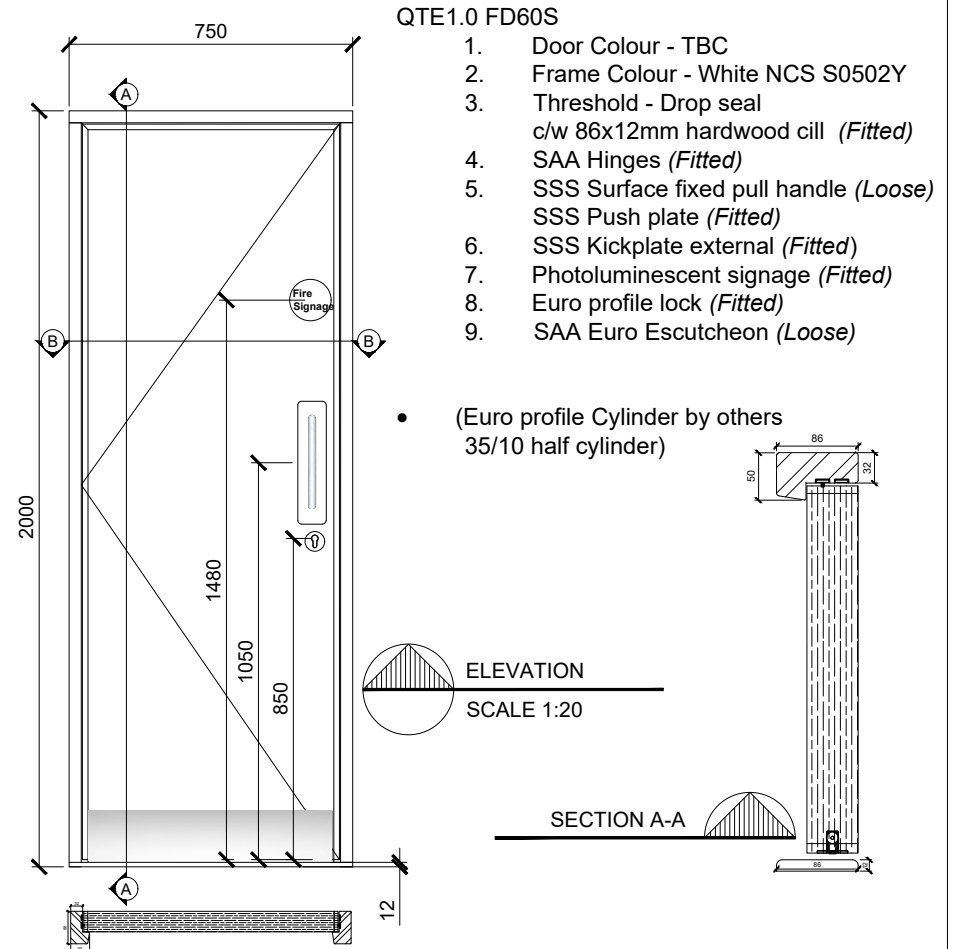
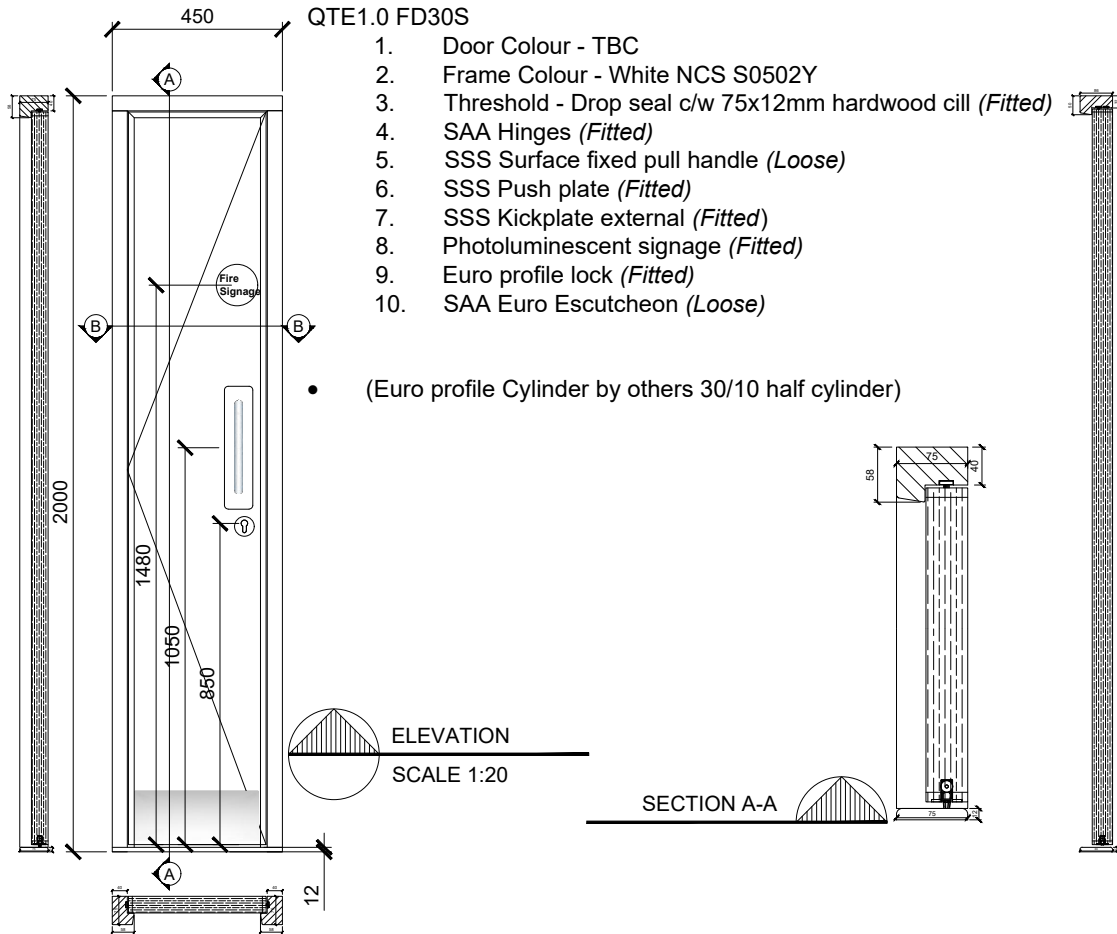

Quote Ref: D36

QTE1.0 FD30S

Handing: LH IN (Hinge viewed externally)
Door Leaf: 364x1938mm (Varies RTT to survey)

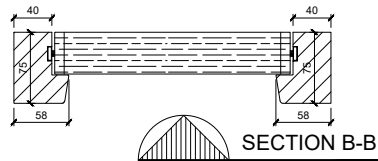

Quote Ref: D37

QTE1.0 FD60S

Handing: LH IN (Hinge viewed externally)
Door Leaf: 680x1946mm (Varies RTT to survey)

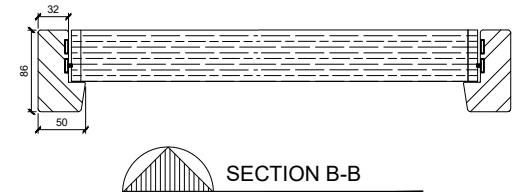

REVISION	ALTERED	DATE	DESCRIPTION

CLIENT: United Living	SITE: X251 Regency & Semley
TITLE: Hide Tower - QTE 1.0 FD30S & QTE1.0 FD60S	John A Russell 8 Dilwara Avenue Whiteinch Glasgow G14 OQS
<p>RUSSELL Timber Technology Engineered to excel</p>	JOB - DRAWING No: 38067-307
	SCALE: NTS@A4 DRAWN BY: JST CHECKED: DATE: 19/08/20

united living
Together we achieve more

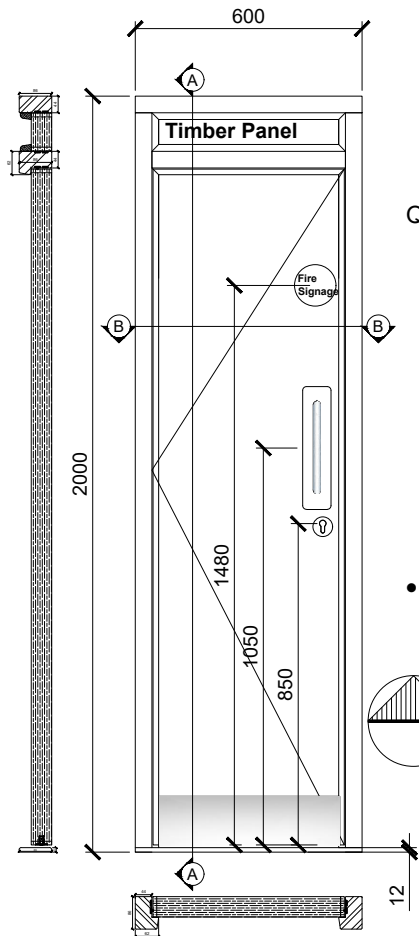

QTE1.0 FD60S c/w FD60S Fanlight

1. Door Colour - TBC
2. Frame Colour - White NCS S0502Y
3. Threshold - Drop seal c/w 86x12mm hardwood cill (*Fitted*)
4. SAA Hinges (*Fitted*)
5. SSS Surface fixed pull handle (*Loose*)
6. SSS Push plate (*Fitted*)
7. SSS Kickplate external (*Fitted*)
8. Photoluminescent signage (*Fitted*)
9. Euro profile lock (*Fitted*)
10. SAA Euro Escutcheon (*Loose*)

- (Euro profile Cylinder by others 35/10 half cylinder)

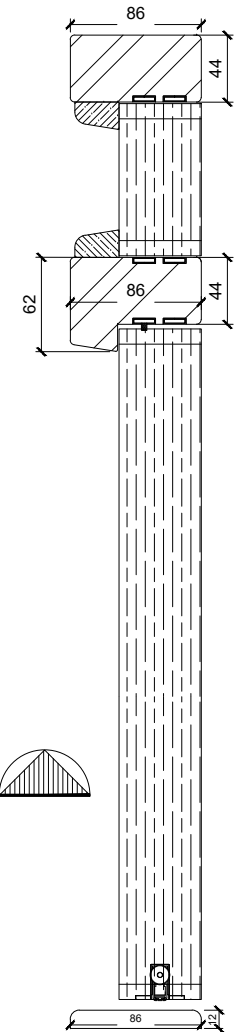
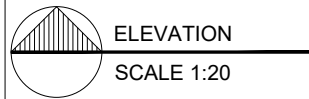

Quote Ref: D38

QTE1.0 FD60S c/w FD60S Fanlight

Handing: LH IN (Hinge viewed externally)
Door Leaf: 506x1788mm (Varies RTT to survey)

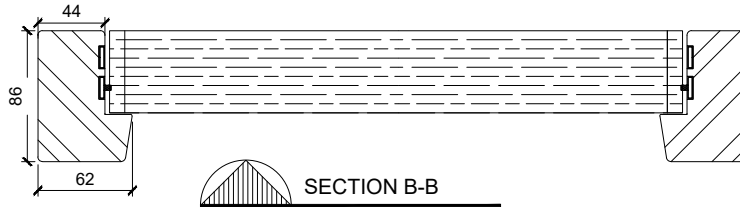

REVISION	ALTERED	DATE	DESCRIPTION

CLIENT: United Living		SITE: X251 Regency & Semley	
TITLE: Hide Tower - QTE1.0 FD60S c/w FD60S Fanlight		John A Russell 8 Dilwara Avenue Whiteinch Glasgow G14 OQS	JOB - DRAWING No: 38067-308
 RUSSELL Timber Technology Engineered to excel	Tel: 0141 958 0444	SCALE: NTS@A4	DRAWN BY: JST
	Fax: 0141 958 0333		CHECKED: []
Web: www.russelltimbertech.co.uk			DATE: 19/08/20



united living

Together we achieve more

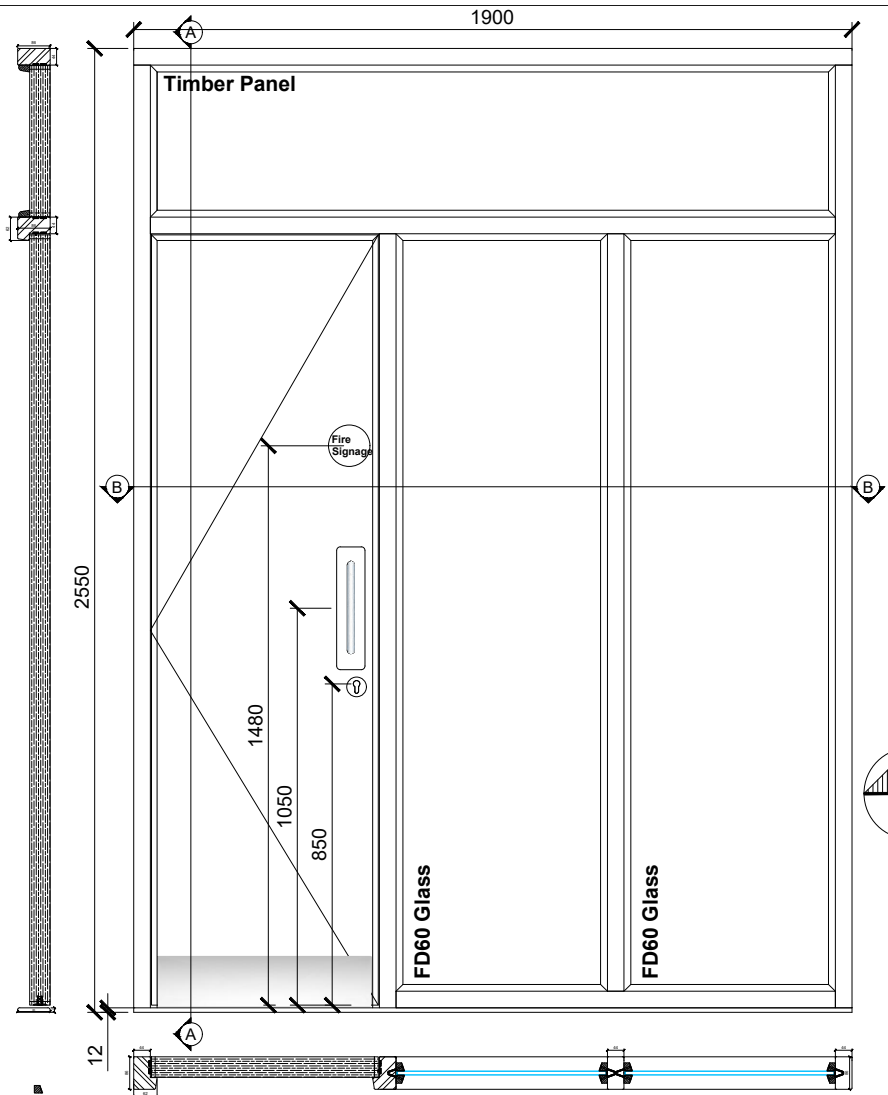

QTE1.0 FD60S c/w FD60S Fanlight & Sidelight

1. Door Colour - TBC
2. Frame Colour - White NCS S0502Y
3. Threshold - Drop seal c/w 86x12mm hardwood cill (*Fitted*)
4. SAA Hinges (*Fitted*)
5. SSS Surface fixed pull handle (*Loose*)
6. SSS Push plate (*Fitted*)
7. SSS Kickplate external (*Fitted*)
8. Photoluminescent signage (*Fitted*)
9. Euro profile lock (*Fitted*)
10. SAA Euro Escutcheon (*Loose*)

- Glass: FD60 Clear
- (Euro profile Cylinder by others 35/10 half cylinder)

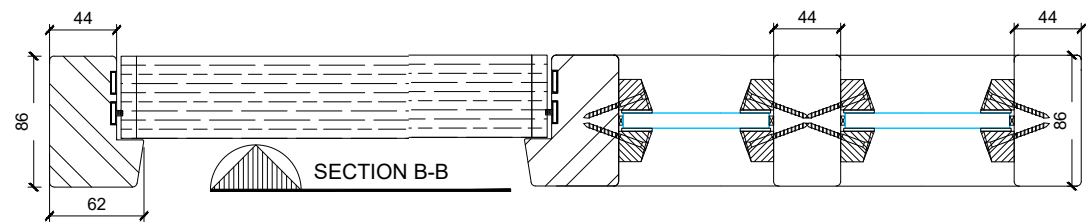
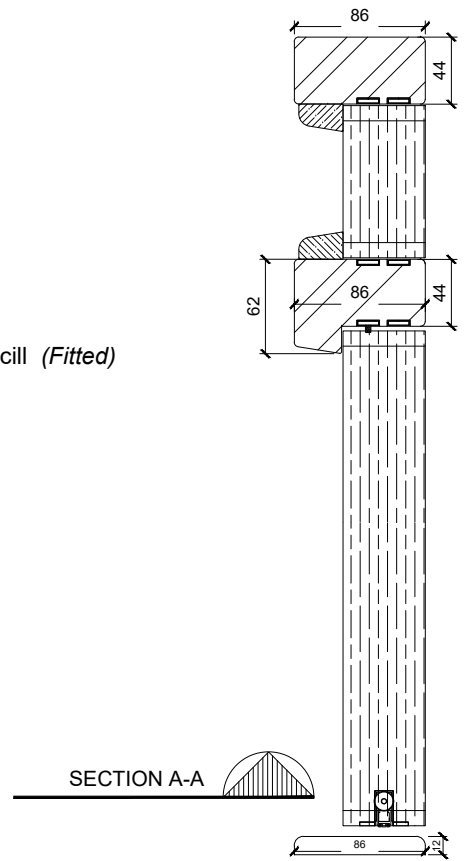
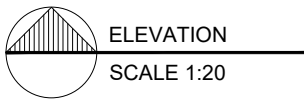

Quote Ref: D39

QTE1.0 FD60S c/w FD60S Fanlight & Sidelight

Handing: LH IN (Hinge viewed externally)
Door Leaf: 600x2038mm (Varies RTT to survey)

REVISION	ALTERED	DATE	DESCRIPTION

CLIENT: United Living	SITE: X251 Regency & Semley		
TITLE: Hide Tower - QTE1.0 FD60S c/w FD60S Fanlight & Sidelight	John A Russell 8 Dilwara Avenue Whiteinch Glasgow G14 OQS	JOB - DRAWING No: 38067-309	SCALE: NTS@A4
 RUSSELL Timber Technology Engineered to excel	Tel: 0141 958 0444	DRAWN BY: JST	CHECKED: DATE: 19/08/20
	Fax: 0141 958 0333	DATE: 19/08/20	
Web: www.russelltimbertech.co.uk		Together we achieve more	



united living
Together we achieve more

QTE1.0 FD30S

1. Door Colour - TBC
2. Frame Colour - White NCS S0502Y
3. Threshold - Drop seal
c/w 75x12mm hardwood cill (*Fitted*)
4. SAA Hinges (*Fitted*)
5. SSS Surface fixed pull handle (*Loose*)
6. SSS Push plate (*Fitted*)
7. SSS Kickplate external (*Fitted*)
8. Photoluminescent signage (*Fitted*)
9. Euro profile lock (*Fitted*)
10. SAA Euro Escutcheon (*Loose*)

• (Euro profile Cylinder by others 30/10 half cylinder)

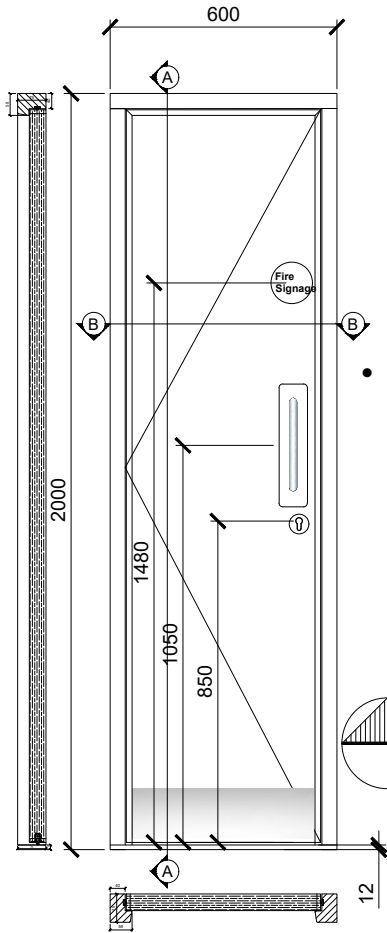

ELEVATION
SCALE 1:20

SECTION A-A

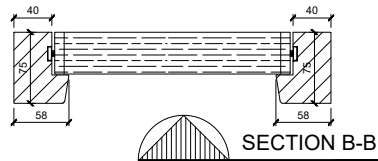

SECTION B-B

Quote Ref: D40

QTE1.0 FD30S

Handing: LH IN (Hinge viewed externally)
Door Leaf: 514x1938mm (Varies RTT to survey)

QTE1.0 FD30S

1. Door Colour - TBC
2. Frame Colour - White NCS S0502Y
3. Threshold - Drop seal
c/w 75x12mm hardwood cill (*Fitted*)
4. SAA Hinges (*Fitted*)
5. SSS Surface fixed pull handle (*Loose*)
SSS Push plate (*Fitted*)
6. SSS Kickplate external (*Fitted*)
7. Photoluminescent signage (*Fitted*)
8. Euro profile lock (*Fitted*)
9. SAA Euro Escutcheon (*Loose*)

• (Euro profile Cylinder by others 30/10 half cylinder)

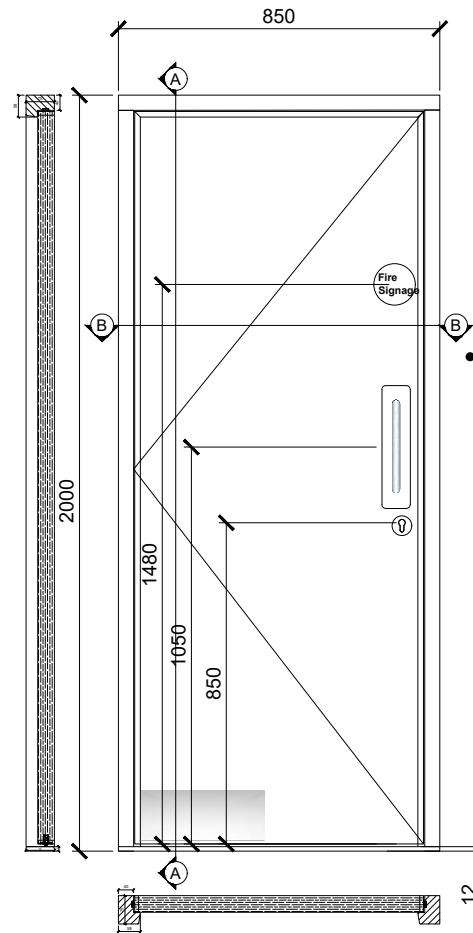

ELEVATION
SCALE 1:20

SECTION A-A

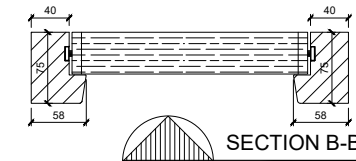

SECTION B-B

Quote Ref: D41

QTE1.0 FD30S

Handing: LH IN (Hinge viewed externally)
Door Leaf: 764x1938mm (Varies RTT to survey)

REVISION	ALTERED	DATE	DESCRIPTION

CLIENT: United Living		SITE: X251 Regency & Semley	
TITLE: Hide Tower - QTE 1.0 FD30S & QTE1.0 FD60S		John A Russell 8 Dilwara Avenue Whiteinch Glasgow G14 OQS	JOB - DRAWING No: 38067-310
	Tel: 0141 958 0444	SCALE: NTS@A4	DRAWN BY: JST
	Fax: 0141 958 0333		CHECKED: DATE: 19/08/20
Web: www.russelltimbertech.co.uk			



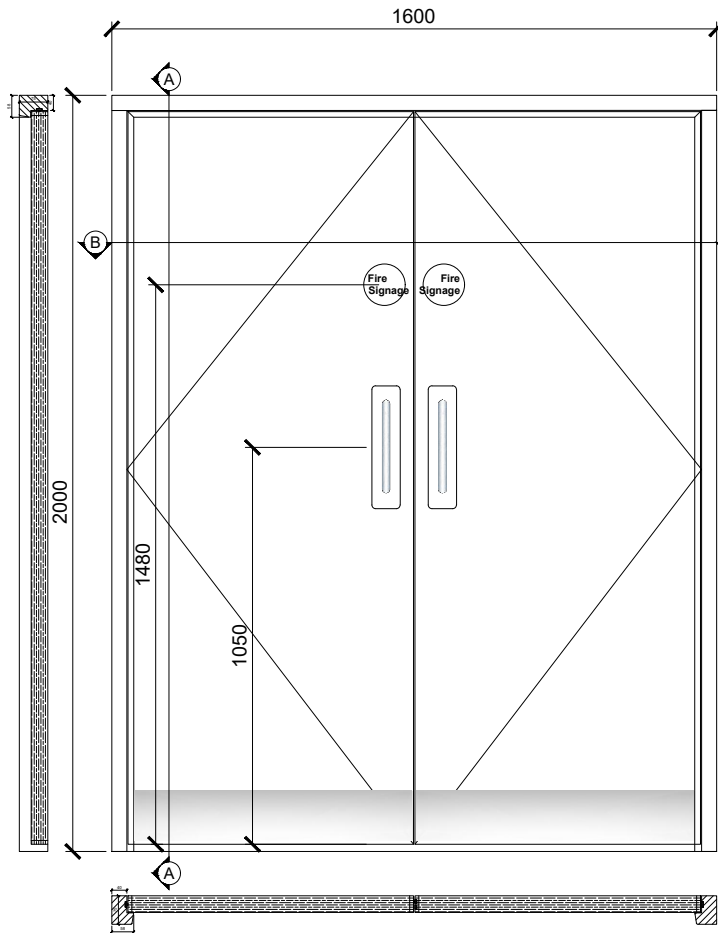

QTE1.0 FD30S Double door

1. Door Colour - TBC
2. Frame Colour - White NCS S0502Y
3. Threshold - Nom 10mm Clearance
4. SAA Hinges (*Fitted*)
5. SSS Surface fixed pull handle (*Loose*)
6. SSS Push plate (*Fitted*)
7. SSS Kickplate external (*Fitted*)
8. Photoluminescent signage (*Fitted*)

- Pass door no locks

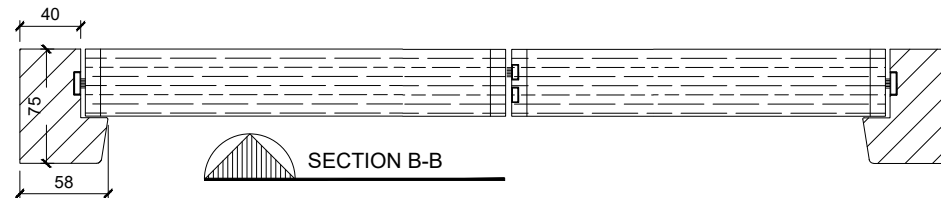
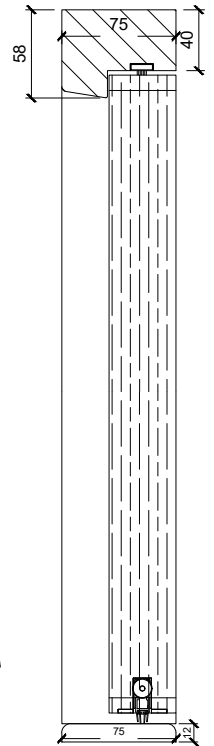
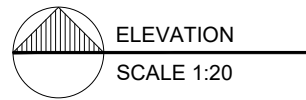

Quote Ref: D42

QTE1.0 FD30S Double door

Handing: LH Lead leaf IN (Hinge viewed externally)
Door Leaf: 755x1938mm (Varies RTT to survey)

REVISION	ALTERED	DATE	DESCRIPTION

CLIENT: United Living	SITE: X251 Regency & Semley
TITLE: Hide Tower - QTE1.0 FD30S Double door	John A Russell 8 Dilwara Avenue Whiteinch Glasgow G14 OQS
 RUSSELL Timber Technology Engineered to excel	JOB - DRAWING No: 38067-311 SCALE: NTS@A4 DRAWN BY: JST CHECKED: DATE: 19/08/20
	 united living <i>Together we achieve more</i>

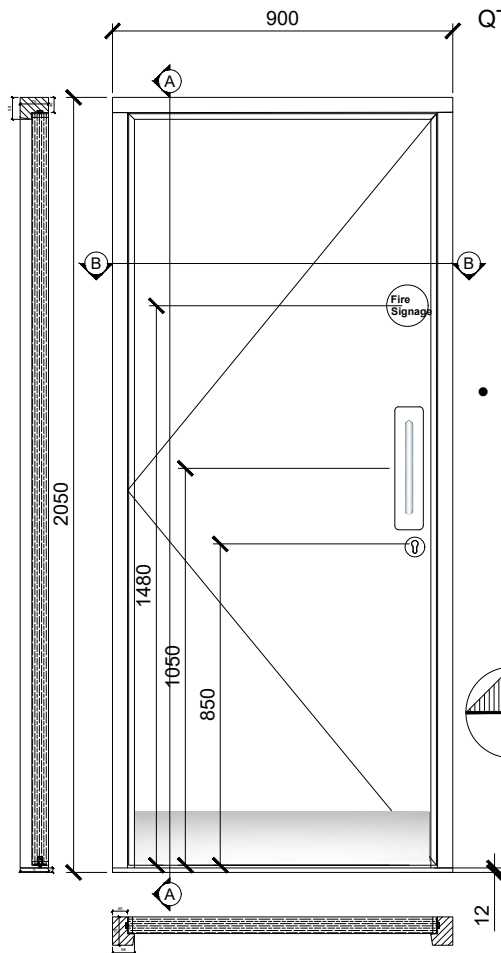

QTE1.0 FD30S

1. Door Colour - TBC
2. Frame Colour - White NCS S0502Y
3. Threshold - Drop seal c/w 75x12mm hardwood cill (*Fitted*)
4. SAA Hinges (*Fitted*)
5. SSS Surface fixed pull handle (*Loose*)
6. SSS Push plate (*Fitted*)
7. SSS Kickplate external (*Fitted*)
8. Photoluminescent signage (*Fitted*)
9. Euro profile lock (*Fitted*)
10. SAA Euro Escutcheon (*Loose*)

- (Euro profile Cylinder by others 30/10 half cylinder)

ELEVATION
SCALE 1:20

SECTION A-A

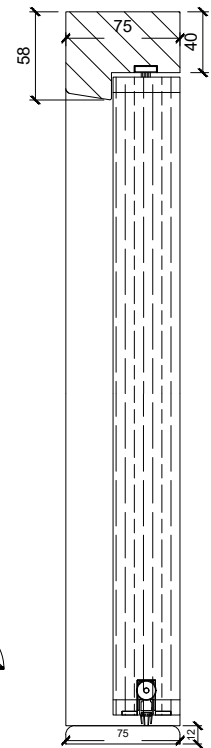

Quote Ref: D43

QTE1.0 FD30S

Handing: LH IN (Hinge viewed externally)
Door Leaf: 814x1987mm (Varies RTT to survey)

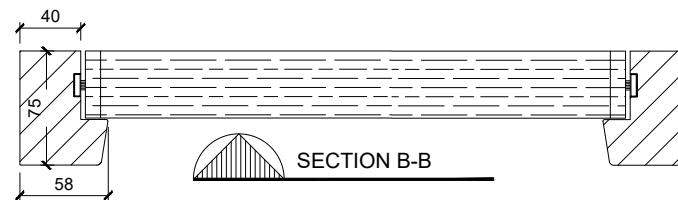

SECTION B-B

REVISION	ALTERED	DATE	DESCRIPTION

CLIENT: United Living	SITE: X251 Regency & Semley
TITLE: Hide Tower - QTE1.0 FD30S	John A Russell 8 Dilwara Avenue Whiteinch Glasgow G14 OQS
 RUSSELL Timber Technology Engineered to excel	JOB - DRAWING No: 38067-312
	SCALE: NTS@A4 DRAWN BY: JST CHECKED: DATE: 19/08/20



united living

Together we achieve more